



**INSTALLATION
AND
OPERATING
INSTRUCTIONS**



**Model DR-2A Hot Dog Broiler
With Optional BH-1A Bun Holder**

MERCHANDISERS

Models: DS-1A, DR-1A, BH-1A

INTENDED FOR OTHER THAN HOUSEHOLD USE

**RETAIN THIS MANUAL FOR FUTURE REFERENCE
UNIT MUST BE KEPT CLEAR OF COMBUSTIBLES AT ALL TIMES**

IMPORTANT FOR FUTURE REFERENCE

Please complete this information and retain this manual for the life of the equipment. For Warranty Service and/or Parts, this information is required.

_____ Model Number

_____ Serial Number

_____ Date Purchased



WARNING: For your safety do not store or use gasoline or other flammable vapors or liquids in the vicinity of this or any other appliance. Keep the area free and clear of combustibles. (See ANZI Z83.14B, 1991)



WARNING: Improper installation, adjustment, alteration, service or maintenance can cause property damage, injury or death. Read the Installation, Operating and Maintenance Instructions thoroughly before installing or servicing this equipment.



This equipment has been engineered to provide you with year-round dependable service when used according to the instructions in this manual and standard commercial kitchen practices.

Phone: +1 (307) 634-5801
Fax: +1 (307) 637-8071
Toll Free: +1 (800) 752-0863
Website: www.apwwyott.com
E-mail: info@apwwyott.com

P/N 457213-00 2/08

APW WYOTT
P.O. Box 1829
Cheyenne, WY 82003

APW Wyott takes pride in the design and quality of our products. When used as intended and with proper care and maintenance, you will experience years of reliable operation from this equipment. To ensure best results, it is important that you read and follow the instructions in this manual carefully.



Installation and start-up should be performed by a qualified installer who thoroughly read, understands and follows these instruction.



If you have questions concerning the installation, operation, maintenance or service of this product, write Technical Service Department APW/Wyott Foodservice Equipment Company, P.O. Box 1829, Cheyenne, WY 82003.



SAFETY PRECAUTIONS



Before installing and operating this equipment be sure everyone involved in its operation are fully trained and are aware of all precautions. Accidents and problems can result by a failure to follow fundamental rules and precautions.



The following words and symbols, found in this manual, alert you to hazards to the operator, service personnel or the equipment. The words are defined as follows:

 **DANGER:** This symbol warns of imminent hazard which will result in serious injury or death. 



 **WARNING:** This symbol refers to a potential hazard or unsafe practice, which could result in serious injury or death. 



 **CAUTION:** This symbol refers to a potential hazard or unsafe practice, which may result in minor or moderate injury or product or property damage. 



 **NOTICE:** This symbol refers to information that needs special attention or must be fully understood even though not dangerous. 



 **CAUTION:** These models are designed, built, and sold for commercial use. If these models are positioned so the general public can use the equipment make sure that cautions, warnings, and operating instructions are clearly posted near each unit so that anyone using the equipment will use it correctly and not injure themselves or harm the equipment. 

 **WARNING:** Improper installation, adjustment, alteration, service or maintenance can cause property damage, injury or death. Read the Installation, Operating and Maintenance Instructions thoroughly before installing or servicing this equipment. 

 **WARNING:** Install per the spacing requirements listed in the installation section of this manual. We strongly recommend having a competent professional install the equipment. A licensed electrician should make the electrical connections and connect power to the unit. Local codes should always be used when connecting these units to electrical power. In the absence of local codes, use the latest version of the National Electrical Code. 

 **WARNING:** For your safety do not store or use gasoline or other flammable vapors or liquids in the vicinity of this or any other appliance. Keep the area free and clear of combustibles. (See ANZI Z83.14B, 1991) 

 **NOTICE:** Instructions to be followed if anyone smells gas should be posted in a prominent place. These may be obtained from the gas supplier. 

 **WARNING:** Check the data plate on this unit before installation. Connect the unit only to the voltage and frequency listed on the data plate. Connect only to 1 or 3 phase as listed on the data plate. 



WARNING: Disconnect device from electrical power supply and place a Tag Out-Lockout on the power plug, indicating that you are working on the circuit.



CAUTION: Maintenance & repair should be handled by a factory authorized agent. Before doing any maintenance or repair, contact APW Wyott.



CONTENTS

Safety Precautions.....	2	Parts Lists & Exploded Views	6
General Information & Troubleshooting.....	3	DR-1A, DR-2A, BH-1A.....	6
DS-1A Mr. Frank Display Steamer.....	4	DS-1A	7
DR-1A Mr. Frank Display Broiler w/BH-1A Bun Warmer.....	5	Warranty	8
Wiring Diagrams: DR-1A, DR-2A and DS-1A	5		

LOCATION OF DATA PLATE

The data plate is located on the back of the unit.

IMMEDIATELY INSPECT FOR SHIPPING DAMAGE

All containers should be examined for damage before and during unloading. The freight carrier has assumed responsibility for its safe transit and delivery. If equipment is received damaged, either apparent or concealed, a claim must be made with the delivering carrier.

- A) Apparent damage or loss must be noted on the freight bill at the time of delivery. It must then be signed by the carrier representative (Driver). If this is not done, the carrier may refuse the claim. The carrier can supply the necessary forms.
- B) Concealed damage or loss if not apparent until after equipment is uncrated, a request for inspection must be made to the carrier within 15 days. The carrier should arrange an inspection. Be certain to hold all contents and packaging material.

Installation and start-up should be performed by a qualified installer who thoroughly read, understands and follows these instructions.

GENERAL INFORMATION & TROUBLESHOOTING



NOTICE: The unit when installed, must be electrically grounded and comply with local codes, or in the absence of local codes, with the national electrical code ANSI/NFPA70- latest edition. Canadian installation must comply with CSA-STANDARD C.22.2 Number 0 M1982 General Requirements-Canadian Electrical Code Part II, 109-M1981- Commercial Cooking Appliances.



NOTICE: Local codes regarding installation vary greatly from one area to another. The National Fire Protection Association, Inc. states in its NFPA96 latest edition that local codes are "Authority Having Jurisdiction" when it comes to requirement for installation of equipment. Therefore, installation should comply with all local codes.



General Installation Instructions:

1. Always clean equipment thoroughly before first use. (See general cleaning instructions.)
2. Check rating label for your model designation and electrical rating.
3. Position equipment on level counter and plug into a grounded outlet so the plug is accessible. (See individual description for electrical loads.) On units bearing the CE marking, the appliance must be connected by an earthing cable to all other units in the complete installation and, hence, to an independent earth connection.

General Operating Instructions:

1. All foodservice equipment should be operated by trained personnel.
2. Do not allow your customers to come in contact with any surface labeled "CAUTION HOT."
3. Where applicable, never pour cold water into dry heated units.
4. Where applicable, do not cook, warm or hold food directly in liner pans (well pans). Always use steam table pans/insets, etc.
5. Never hold food below 150°F (66°C).

General Cleaning Instructions:

1. NEVER clean any electrical unit by immersing it in water. Unplug unit before surface cleaning.
2. Always clean equipment thoroughly before first use. Clean unit daily. Except where noted on charts, use warm, soapy water. Mild cleansers and PLASTIC scouring pads may be used to remove baked-on food and water scale.
3. Unplug all units before cleaning or servicing. All service should be performed by an APW authorized service agency.
4. Do not use chlorides or chloride-based products in this unit. Always clean equipment before first use. Clean unit daily. Use warm, soapy water. Rinse thoroughly to remove all residue. Chlorides, chloride-based products and improper cleaning may cause corrosion and pitting.



CAUTION: Use only non-abrasive cleaners. Abrasive cleaners could scratch the finish of your unit, marring it's appearance and making it susceptible to dirt accumulation. Do Not use steel wool, other abrasive cleaners or cleaners/sanitizers containing chlorine, iodine, ammonia or bromine chemicals as these will deteriorate the stainless steel and glass material and shorten the life of the unit.



WARNING: Unit is not waterproof. To avoid electrical shock or personal injury, **DO NOT** submerge in water. **DO NOT** operate if it has been submerged in water. **DO NOT** clean the unit with a water jet. **DO NOT** steam clean or use excessive water on the unit.



Failure to comply with these instructions may void unit warranty.

General Troubleshooting—Always ask and/or check:

1. Is the unit plugged in?
2. Check circuit breaker.
3. Is power switch on and pilot light glowing?
4. Check rating label. Are you operating unit on proper voltage?
5. If the supply cord is damaged, it should only be replaced by an identical supply cord.

If the above checks out and you still have problems, call an APW authorized service agency.

DS-1A—MR. FRANK DISPLAY STEAMER

Installation:

1. Follow general installation instructions on page 3.
2. The operator must slide basket in over support pins and support flange.

Operations:

1. Follow general operation instructions on page 4.
2. Pour 3 quarts of hot water, 120°-140°F (50°-60°C), into lower pan. Cap on drain pipe must be finger tight.
3. Place perforated hot dog tray into lower compartment. Load with up to 150 hot dogs.
4. Heat up time will depend on size and temperature of the hot dogs. Place bun basket into upper cabinet, slide drip shield on top of bun basket, load up to 60 buns. Buns may be stored in plastic bag for prolonged holding periods.
5. Turn on unit. Set infinite control to "HI" position to begin steaming.
6. For holding, readjust control to "4" or "5" setting after 15 minutes (or when water steams).
7. Add water to unit if level is low.

Cleaning:

1. Follow general cleaning instructions on page 4.
2. Turn off unit and allow cabinet to cool.
3. Unscrew drain cap and drain water from cabinet.
4. Remove trays, baskets and support shelves from cabinet. Clean thoroughly

DR-1A—MR. FRANK DISPLAY BROILER WITH BH-1A BUN WARMER

Installation:

1. Follow general installation instructions on page 3. The broiler is labeled “Caution Hot.” Do not allow customers to come in contact with the hot surface.
2. Insert basket holder assembly into cabinet by placing shaft end into spring loaded fitting. Connect slotted coupling end over motor shaft by compressing spring loaded fitting.
3. Place individual baskets into support holes on hold assembly. Open side of basket should always face operator.
4. Slide drip pan into cabinet under the basket assembly.
5. If optional bun warmer is used, place warmer into opening on top of broiler.

Operations:

1. Follow general operating instructions on page 4.
2. Switch on unit. Set infinite control to “HI” position to begin broiling.
3. Load each basket with up to 4 hot dogs. Use “Load/Unload” push button.
4. Heat up time will depend on the size and temperature of the hot dogs when loaded into the baskets.
5. For holding, readjust control to “5” or “6” setting after 15 minutes. If control is left on “HI,” hot dogs will blister. To display hot dogs for several hours without shriveling or flavor loss, Do Not Pierce Casings.
6. If optional bun warmer is used, pour 1 quart of hot water, 120°-140°F (50°-60°C), into pan. Load up to 36 buns. Attach drip shield. Buns may be stored in plastic bag for prolonged holding periods.
7. Use LOAD/UNLOAD push button to remove hot dogs from unit.
8. Add water as necessary to maintain moist buns.

Daily Cleaning:

1. Follow general cleaning instructions on page 4 .

WIRING DIAGRAMS

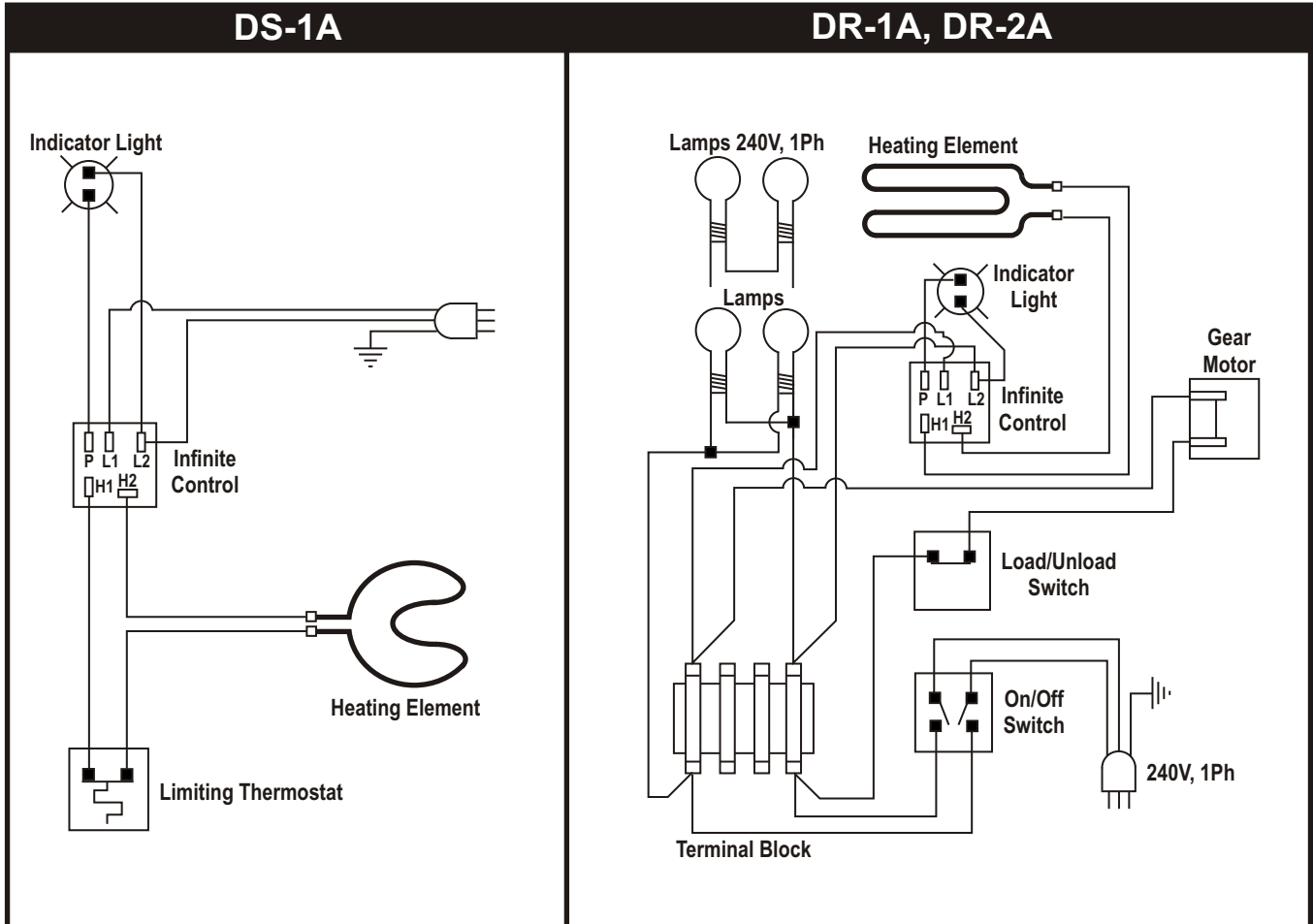

PARTS LISTS w/EXPLODED VIEWS



P.O. Box 1829
Cheyenne, WY 82003

DR-1A, DR-2A, BH-1A

Display Hot Dog Broiler

Phone: +1 (307) 634-5801
 Fax: +1 (307) 637-8071
 Toll Free: +1 (800) 752-0863
 Website: www.apwwyott.com
 E-mail: info@apwwyott.com

HOT DOG ROASTER DR-1A & DR-2A & BUN HOLDER BH-1A

Item	Part No.	Description
1	44685200	Wrapper Assembly
2	44685400	Control Housing
3	44680200	Large Glass
4	44680100	Small Glass
5	8967200	1/2 Inch Hole Bushing
6	44686600	Top Cover
7	44687000	Reflector Assembly
8	1506000	Lamp Holder
9	2002300	Nipple, Lamp Holder
10	2000300	Nut, Lamp Holder
11	44687800	Heating Element 120V
12	44683100	Heating Element 240V
13	1505800	Lamp Bulb
14	1196100	Wire Nut
15	47255900	Cord 120V
16	1547000	Cord 240V
17	8968900	Strain Relief Bushing
18	48609300	Conveyor Motor 120V
19	44683800	Conveyor Motor 240V
N/S	83006-00	Motor Drive Roll Pin
21	48914500	Terminal Block
22	48521000	Conveyor Idler Bearing
23	1301608	Infinite Control 120V
24	1301602	Infinite Control 240V
25	45582500	Knob, Infinite Control
26	48940600	On-Off Switch
27	44687500	Load Push Switch
28	45653000	Indicator Light
29	44689500	Inspection Panel
30	44689100	Conveyor Carousel
31	44685000	Basket (Each)
32	44685600	Drip Pan
33	44687400	Top Hole Cover
34	44681200	Bottom Cover
35	45576800	Foot (Each)
N/S	21766800	Marketing Label
37	44688100	Wrapper & Top Assembly
38	44688500	Door Assembly
39	47253300	Handle, Door
40	44689000	Bun Basket
41	44680300	Drip Shield
42	8705000	Magnet Door
43	44674900	Magnet Plate, Door (Ralley's)
N/S	446851	DR-1A 120V Unit
N/S	446825	DR-2A 120V Unit
N/S	446832	DR-1A 240V Unit
N/S	446830	DR-2A 240V Unit
N/S	446880	Bun Holder

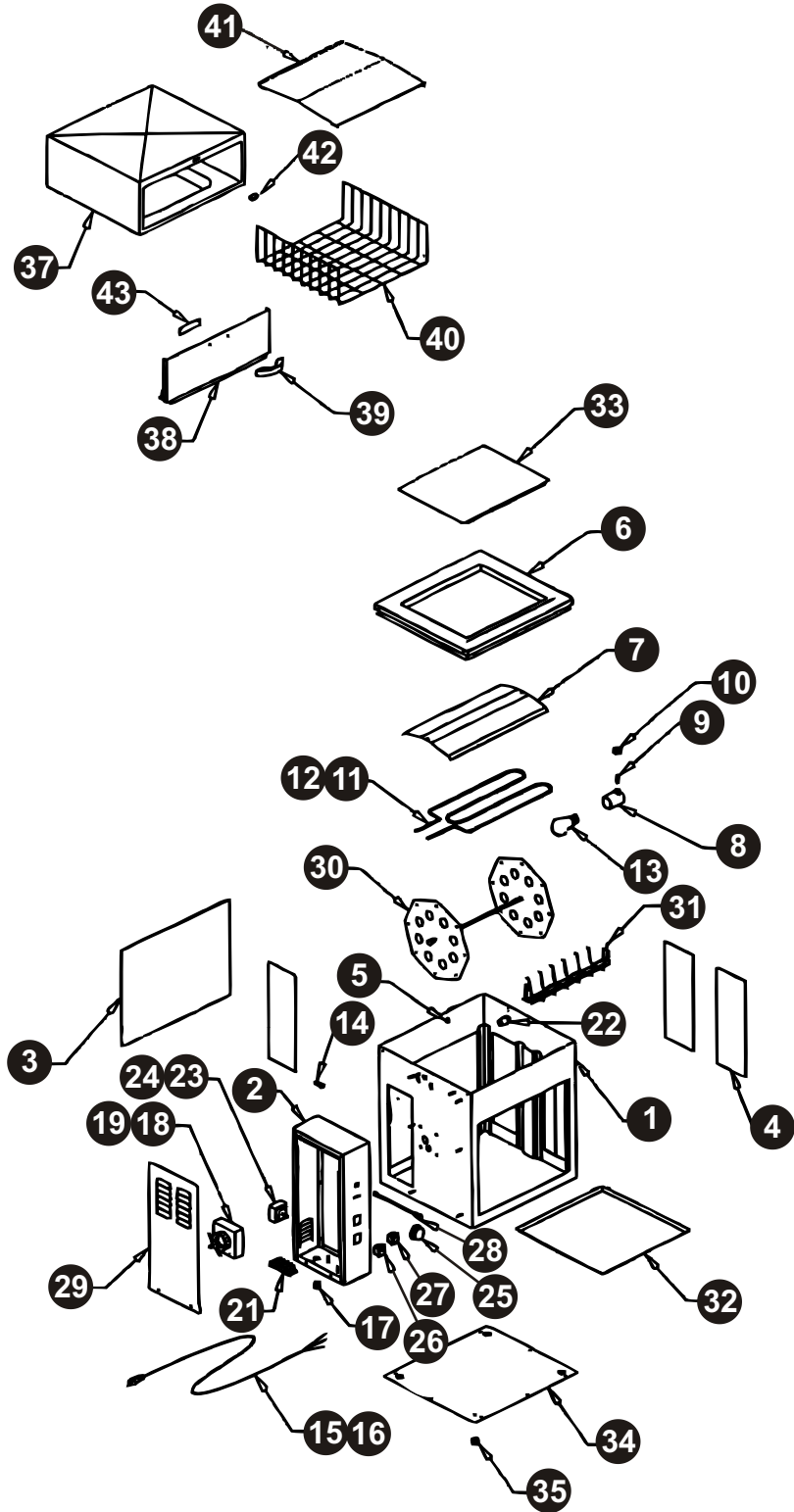



P.O. Box 1829
Cheyenne, WY 82003

DS-1A

Hot Dog Steamer

Phone: +1 (307) 634-5801
 Fax: +1 (307) 637-8071
 Toll Free: +1 (800) 752-0863
 Website: www.apwwyott.com
 E-mail: info@apwwyott.com

HOT DOG STEAMER DS-1A

Item	Part No.	Description
1	44662900	Upper Wrapper Assembly
2	44680200	Glass
3	44661100	Bottom Wrapper Assembly
4	44663100	Door Assembly
5	44660900	Hot Dog Tray
6	44689000	Bun Basket
7	44675600	Drip Shield
8	44661300	Basket Support
9	44681200	Bottom Cover
10	45576800	Rubber Foot (each)
11	44677500	Drain Cap Assembly
12	44676100	Drain Cap Only
13	44675000	Drain Cap Chain
14	44676200	Rubber Gasket
15	1301608	Infinite Control (120V)
	1301602	Infinite Control (240V)
16	45582500	Knob, Infinite Control
17	45653000	Indicator Light
18	47255900	Cord, Power 120V
	47255900	Cord, Power 240V (Remove Plug)
19	8968900	Strain Relief Bushing
20	46910700	High Limit Thermostat
21	45596000	Heating Element 120V, 800W
22	45081700	Heat Transfer Plate
23	45569500	Element Clamp
24	45569600	Anti-Rotation Clamp
25	45599200	Element Cover
26	21766800	Label, Marketing
27	48970100	Label, Caution Hot
28	8978400	Hole Bushing 7/8"
N/S	8422400	10-24 Green Hex Nut
N/S	8422300	10-24 Hex Nut
N/S	48902500	10-24 Speed Nut
N/S	8128700	Screw, Drive, Type AB 8-18

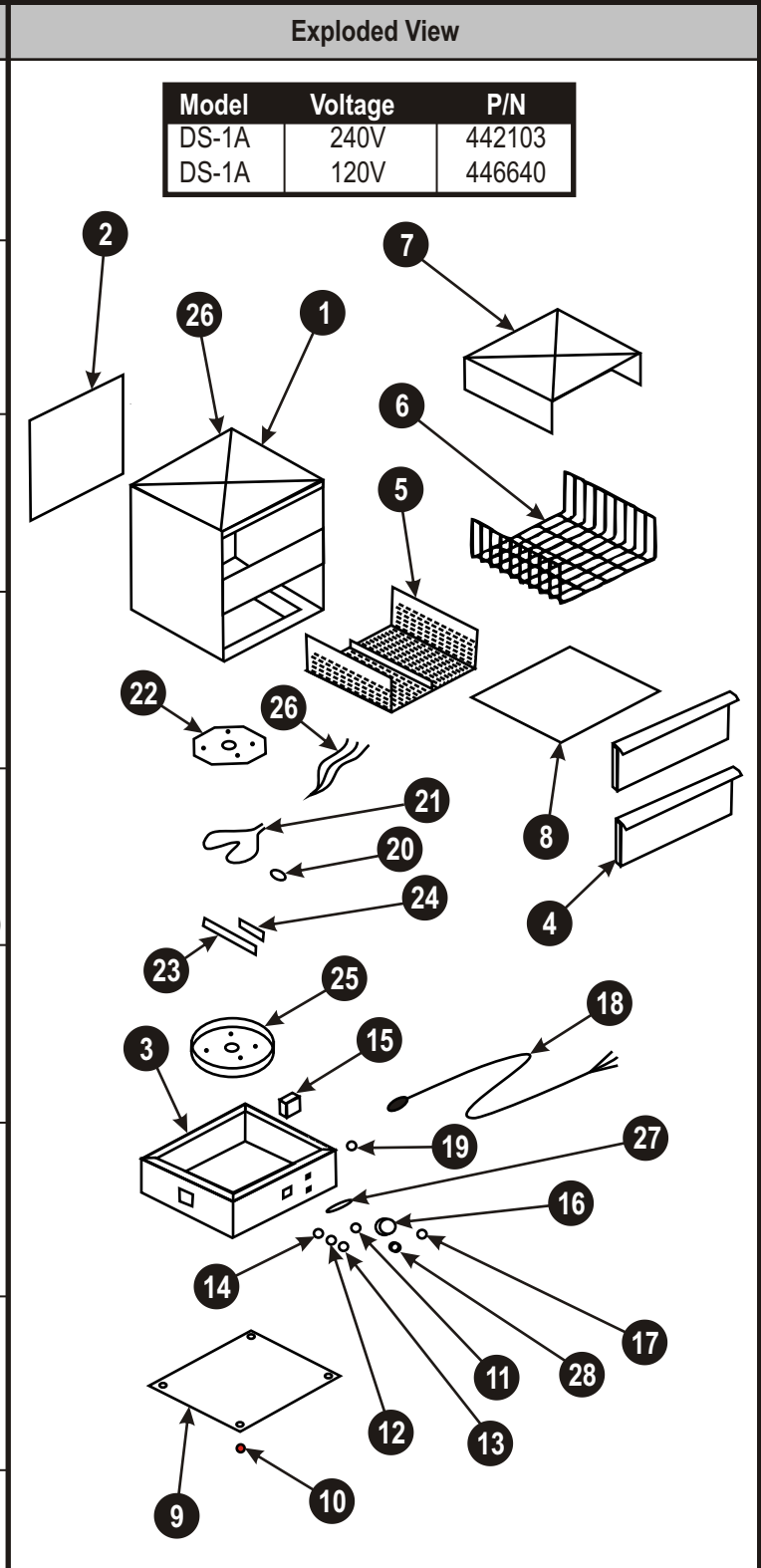

APW WYOTT EQUIPMENT LIMITED WARRANTY

APW Wyott Foodservice Equipment Company warrants its equipment against defects in materials and workmanship, subject to the following conditions:

This warranty applies to the original owner only and is not assignable.

Should any product fail to function in its intended manner under normal use within the limits defined in this warranty, at the option of APW Wyott such product will be repaired or replaced by APW Wyott or its Authorized Service Agency. APW Wyott will only be responsible for charges incurred or service performed by its Authorized Service Agencies. The use of other than APW Wyott Authorized Service Agencies will void this warranty and APW Wyott will not be responsible for such work or any charges associated with same. The closest APW Wyott Authorized Service Agent must be used.

This warranty covers products shipped into the 48 contiguous United States, Hawaii, metropolitan areas of Alaska and Canada. There will be no labor coverage for equipment located on any island not connected by roadway to the mainland.

Warranty coverage on products used outside the 48 contiguous United States, Hawaii, and metropolitan areas of Alaska and Canada may vary. Contact the international APW Wyott distributor, dealer, or service agency for details.

Time Period

One year for parts and one year for labor, effective from the date of purchase by the original owner. The Authorized Service Agency may, at their option, require proof of purchase. Parts replaced under this warranty are warranted for the un-expired portion of the original product warranty only.

Exceptions

***Gas/Electric Cookline:** Models GCB, GCRB, GF, GGM, GGT, CHP-H, EF, EG, EHP. Three (3) Year Warranty on all component parts, except switches and thermostats. (2 additional years on parts only. No labor on second or third year.)

***Broiler Briquettes, Rock Grates, Cooking Grates, Burner Shields, Fireboxes:** 90 Day Material Only. No Labor.

***Heat Strips:** Models FD, FDL, FDD, FDDL. Two (2) Year Warranty on element only. No labor second year.

***Glass Windows, Doors, Seals, Rubber Seals, Light Bulbs:** 90 Day Material Only. No Labor.

In all cases, parts covered by extended warranty will be shipped FOB the factory after the first year.

Portable Carry In Products

Equipment weighing over 70 pounds or permanently installed will be serviced on-site as per the terms of this warranty. Equipment weighing 70 pounds or under, and which is not permanently installed, i.e. with cord and plug, is considered portable and is subject to the following warranty handling limitations. If portable equipment fails to operate in its intended manner on the first day of connection, or use, at APW Wyott's option or its Authorized Service Agency, it will be serviced on site or replaced.

From day two through the conclusion of this warranty period, portable units must be taken to or sent prepaid to the APW Wyott Authorized Service Agency for in-warranty repairs. No mileage or travel charges are allowed on portable units after the first day of use. If the customer wants on-site service, they may receive same by paying the travel and mileage charges. Exceptions to this rule: (1) countertop warmers and cookers, which are covered under the Enhanced Warranty Program, and (2) toasters or rollergrills which have in store service.

Exclusions

The following conditions are not covered by warranty:

*Equipment failure relating to improper installation, improper utility connection or supply and problems due to ventilation.

*Equipment that has not been properly maintained, calibration of controls, adjustments, damage from improper cleaning and water damage to controls.

*Equipment that has not been used in an appropriate manner, or has been subject to misuse or misapplication, neglect, abuse, accident, alteration, negligence, damage during transit, delivery or installation, fire, flood, riot or act of god.

*Equipment that has the model number or serial number removed or altered.

If the equipment has been changed, altered, modified or repaired by other than an Authorized Service Agency during or after the warranty period, then the manufacturer shall not be liable for any damages to any person or to any property, which may result from the use of the equipment thereafter.

This warranty does not cover services performed at overtime or premium labor rates. Should service be required at times which normally involve overtime or premium labor rates, the owner shall be charged for the difference between normal service rates and such premium rates. APW Wyott does not assume any liability for extended delays in replacing or repairing any items beyond its control.

In all cases, the use of other than APW Wyott Authorized OEM Replacement Parts will void this warranty.

This equipment is intended for commercial use only. Warranty is void if equipment is installed in other than commercial application.

Water Quality Requirements

Water supply intended for a unit that has in excess of 3.0 grains of hardness per gallon (GPG) must be treated or softened before being used. Water containing over 3.0 GPG will decrease the efficiency and reduce the operation life of the unit.

Note: Product failure caused by liming or sediment buildup is not covered under warranty.

“THE FOREGOING WARRANTY IS IN LIEU OF ANY AND ALL OTHER WARRANTIES EXPRESSED OR IMPLIED INCLUDING ANY IMPLIED WARRANTY OF MERCHANTABILITY OR FITNESS FOR PARTICULAR PURPOSES AND CONSTITUTES THE ENTIRE LIABILITY OF APW WYOTT. IN NO EVENT DOES THE LIMITED WARRANTY EXTEND BEYOND THE TERMS STATED HEREIN.”

9/05